

Ladder Barrel



Please review this important **assembly, safety** and **warranty** information about your new Merrithew™ equipment and keep it handy for future reference.

IMPORTANT!

IMPROPER USE OF EXERCISE EQUIPMENT MAY CAUSE SERIOUS BODILY INJURY. TO REDUCE RISK, PLEASE READ THE FOLLOWING:

- ▶ Before starting any exercise program, consult a physician.
- ▶ The Ladder Barrel must be used under the supervision of a trained professional.
- ▶ Use equipment only for intended exercises.
- ▶ Stop exercising if you experience chest pain, feel faint, have difficulty breathing or experience musculoskeletal discomfort.
- ▶ Do not use if equipment appears worn, broken or damaged.
- ▶ Do not attempt to repair equipment yourself without consulting Merrithew.
- ▶ Do not allow children to use or be around equipment without adult supervision.
- ▶ The Ladder Barrel should be used by only one person at a time, not weighing over 350 lbs / 159 kgs.
- ▶ Proper maintenance and timely replacement of your equipment is your responsibility and helps reduce the risk of injury.

Mechanical Safety Check

Like any mechanical device, Pilates equipment and its components are subject to wear and stress.

Proper maintenance and timely replacement of your equipment or component parts is your responsibility as it helps reduce the risk of injury. Conduct a regular inspection of the following:

Daily

- ▶ Clean all surface areas after each use, using a soft cloth and gentle cleanser.

Monthly

- ▶ Check that all screws are fully tightened and dowels are secure.
- ▶ Check wear on all star knob threads, replace as needed.

FAILURE TO PERFORM RECOMMENDED SAFETY CHECKS, OR USING EQUIPMENT WITH IMPROPERLY ADJUSTED, BROKEN OR WORN PARTS, COULD RESULT IN SERIOUS BODILY INJURY.

User Guidelines

Pilates equipment when used effectively can facilitate many Pilates exercises safely and effectively. However, care and caution must be taken as there are some inherent dangers when using any exercise equipment.

For inexperienced or first-time users, this equipment should only be used under the supervision of a trained professional.

Please ensure that you and your clients/patients have received proper instruction regarding the correct and safe use of this equipment.

This manual includes general guidelines for setup and usage. To get the most out of this equipment, Merrithew offers instructional DVDs and manuals. Personalized training is offered through our Corporate, Licensed and Host Training Centers. Visit merrithew.com for more information.

Safety and Usage

The Ladder Barrel is an innovative piece of equipment that, when used properly, can facilitate many Pilates exercises safely and effectively.

- ▶ Proper fitness apparel, including sticky socks is recommended while using this equipment.
- ▶ We recommend using a gripper mat to provide additional traction.
- ▶ To prevent unsafe or improper use of Merrithew equipment, please read all assembly and safety information thoroughly and follow directions carefully. Contact the manufacturer if you have any questions or concerns.
- ▶ To reduce the risk of injury, use a mat or exercise pad on wood or other hard surfaces.
- ▶ If necessary, wipe any sweat off upholstered surfaces while working out.
- ▶ Please ensure that you and your clients/patients receive proper instruction regarding the correct and safe use of this equipment.

WARNING: As with any athletic activity, the use of exercise equipment involves risk of injury, damage and/or death.

By choosing to use Merrithew equipment, you and/or your clients/patients assume responsibility for that risk, not the people who sell, distribute and/or manufacture this equipment.

Care and Cleaning

Wipe vinyl surfaces using warm water with mild soap and clear water rinses for day-to-day cleaning. Ensure soap does not leave an oily residue, or make surfaces slippery.

Clean all metal surface areas as required, using a soft cloth and gentle cleaner.

CAUTION: We do not recommend using chemical-based products.



3/16" Hex Key (supplied)

Ladder Barrel

- 1 Easy-Roll Wheels [fig. C]
- 2 Sliding Base [fig. A]
- 3 Star Knobs with Washers [fig. A]
- 4 Barrel
- 5 3/4" Baltic Birch Side Panels
- 6 22" Maple Dowels
- 7 Metal Frame
- 8 Plastic Feet
- 9 32" Maple Dowel
- 10 3/8" x 3/4" Socket Head Cap Screws [fig. B]

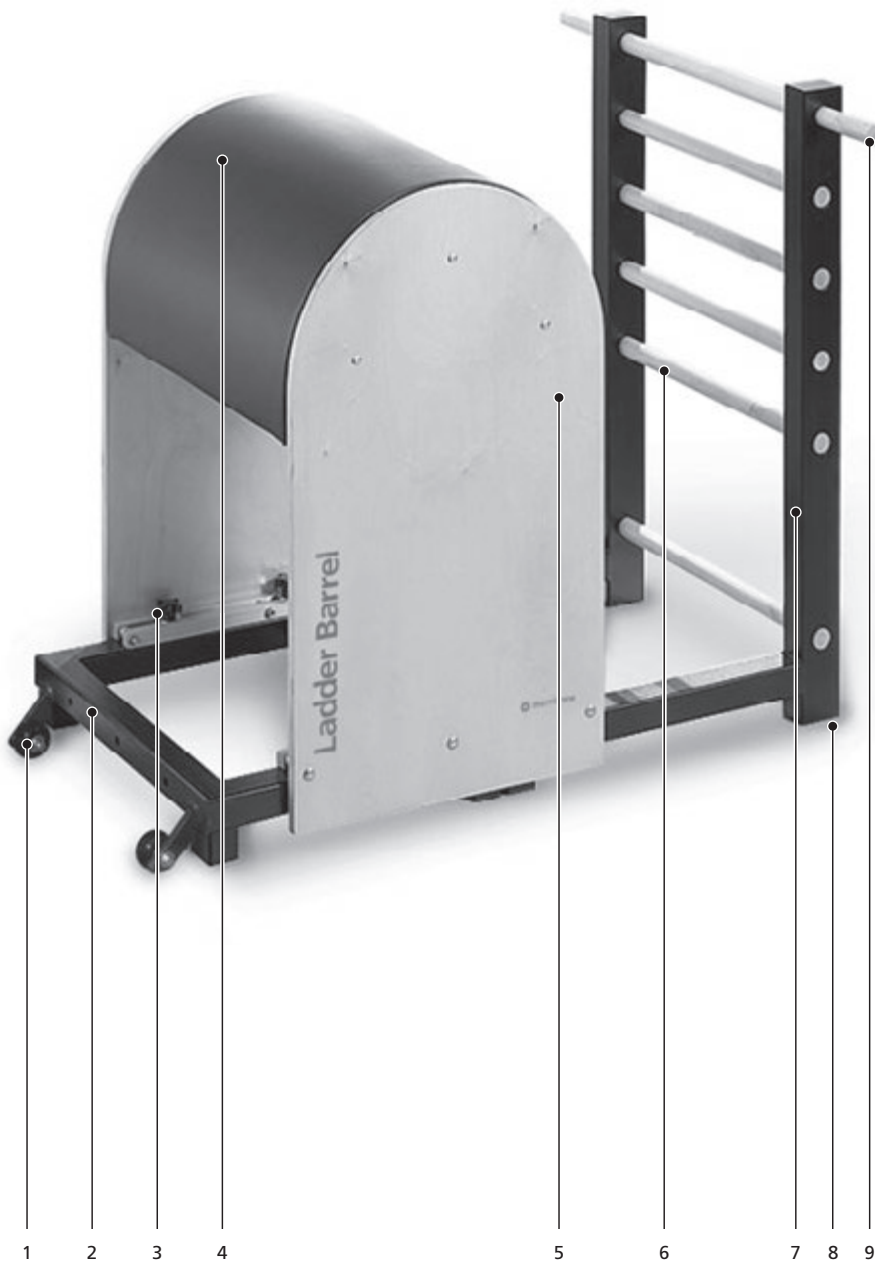
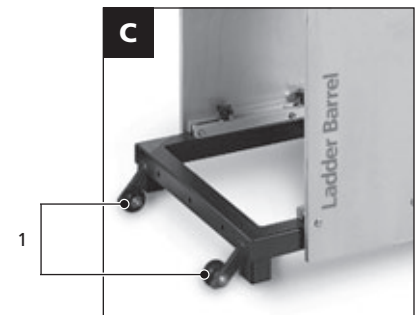
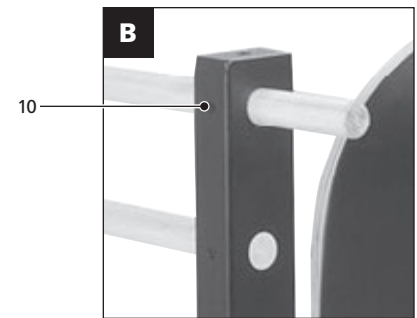
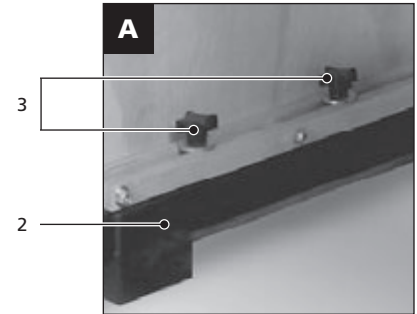

Assembling the Ladder Barrel

IMPORTANT: DO NOT TIGHTEN ANY BOLTS OR SCREWS DURING ASSEMBLY UNTIL INSTRUCTED TO DO SO.

- ▶ Place all parts from the box in a cleared area and position them on the floor in front of you.
- ▶ Remove all packing materials from the area and place them back into the box. Do not dispose of the packing materials until assembly is completed.
- ▶ To prevent unsafe or improper use, please read each step carefully before beginning.

Installing Maple Dowel

Center 32" maple dowel [9] on metal frame [7] as shown, so that 5" protrudes on either side [fig. D]. Tighten 3/8" x 3/4" socket head cap screws securely, [10] using 3/16" hex key.

Adjusting Ladder

The Ladder Barrel can be easily adjusted to accommodate different body sizes. To adjust barrel, loosen all four star knobs (located immediately above sliding frame) [fig. E] and move sliding base along metal frame. Secure by tightening all four star knobs.

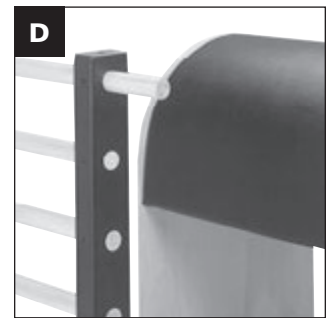
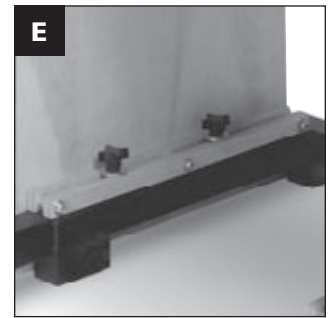
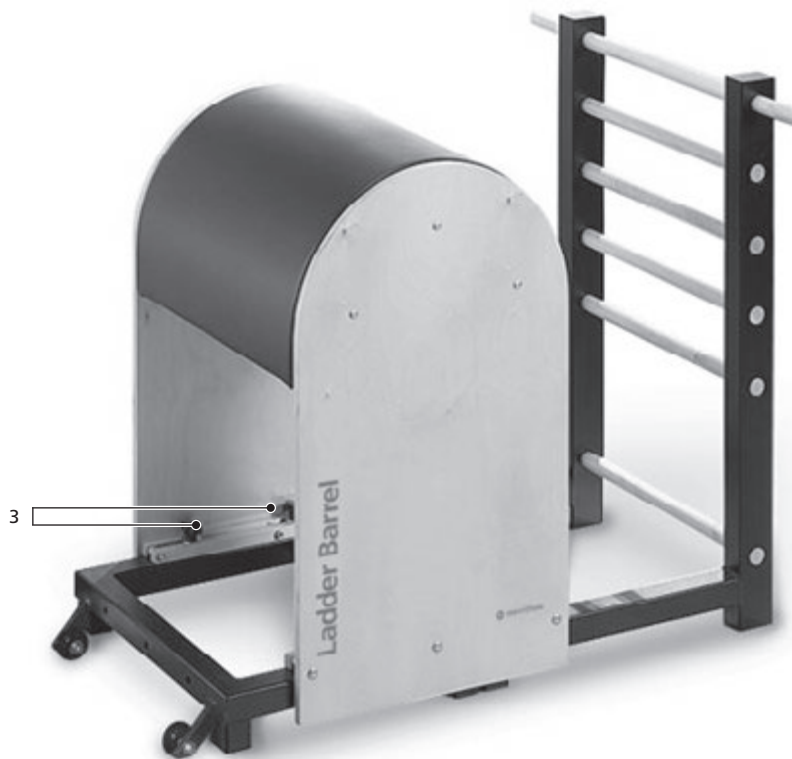

Replacement Parts

For more information and to place an order, visit merrithew.com/replacementparts or email equipment@merrithew.com

Star Knob



Use to lock or unlock the sliding base.

ACCESSORIES

Optional Items

Gripper Mat

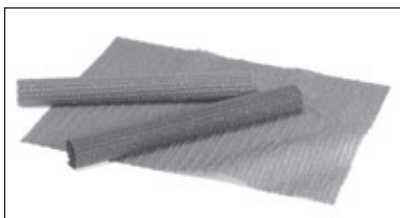

Non-slip rubber mats are handy to increase traction and prevent slipping. A gripper mat can be wrapped around push-thru bar, roll-down bar, uprights or placed on upholstered bed.

Eco-Friendly Pilates Pad



Non-slip eco-friendly pads can help establish correct alignment and positioning or to provide cushioned support.

Roll-Up Pole



This solid maple roll-up pole is used to increase focus on scapular stabilization while performing exercises. Sold separately.

Warranty

Merrithew™ warrants that all new equipment is free of manufacturing defects in workmanship and materials, subject to the terms below. This warranty becomes effective at the invoice date of the original purchase. Parts repaired or replaced under the terms of this warranty will be warranted for the remainder of the original warranty period.

It is the purchaser's responsibility to notify the Company of any change of contact information. This ensures, that in the unlikely event of a replacement or safety notice, we are able to contact you immediately.

This warranty applies to equipment only:

- ▶ While it remains in the possession of the original purchaser and proof of purchase is demonstrated
- ▶ If claims are made within the part-specific warranty period
- ▶ If upgrades are made as required by Merrithew

This warranty shall be null and void if:

- ▶ **Equipment failure is a result of improper assembly, installation or maintenance**
- ▶ **The equipment is used for any other purpose other than as intended, or is stored or used outdoors, or in environments without adequate climate/humidity controls**
- ▶ **Equipment has been subjected to accident, misuse, abuse, improper service, or any modification not authorized by Merrithew**

This warranty does not cover damage to the finish of any equipment nor shipping charges, customs clearance fees (if applicable), or any costs incurred in installing repaired or replacement parts shipped under the provisions of this warranty.

Limited Lifetime Warranty

Merrithew will, at its option, repair or replace any of the parts listed below, provided that the part(s) fail due to a defect in workmanship or materials and provided such failure occurs and is reported with part-specific warranty period.

Two (2) Year Limited Warranty

Merrithew will, at its option, repair or replace all other components, including spring holder, springs and High-Traction Reformer Feet that fail for any reason, provided such failure is reported to Merrithew within a period of two years from the invoice date of the original purchase.

90-Day Upholstery Fabric Warranty

The vinyl fabric upholstery will be replaced if they fail to give normal wear for 90 days after delivery. Proof of damage may be required. This warranty does not cover cuts, burns, stains, soiling, pet damage or damage caused by other unreasonable use.

This warranty does not apply to fabrics cleaned with abrasive, corrosive or chemical cleansers. If the identical fabric is not available, Merrithew will provide an equivalent.

Disclaimer of Implied Warranties and Limitation of Remedies

Repair or replacement of defective parts is your exclusive remedy under the terms of this limited warranty. In the event of parts availability issues, Merrithew will not be responsible for any consequential or incidental damages arising from the breach of either this limited warranty or any applicable implied warranty, or for failure or damage resulting from acts of nature, improper care and maintenance, accident, alteration, replacement of parts by anyone other than Merrithew, misuse, transportation, abuse, hostile environments (inclement weather, acts of nature), improper installation or installation not in accordance with local codes or printed instructions.

This limited warranty is the sole express warranty given by Merrithew. No product performance, specification or description wherever appearing is warranted by Merrithew except to the extent set forth in this limited warranty. Any implied warranty protection arising under the laws of any state, province or territory including implied warranty of merchantability or fitness for a particular purpose, or use, is hereby limited in duration to the duration of this limited warranty.

Neither distributors, dealers, web resellers, nor the retailers selling this product have any authority to make any additional warranties or to promise remedies in addition to, or inconsistent with those stated above. Merrithew's maximum liability, in any event, shall not exceed the purchase price of the product paid by the original purchaser.

IMPORTANT

Please keep this manual in a safe place.

If you have questions, issues or are missing parts:

Do NOT return this unit to your local retailer, please contact the manufacturer directly.

customercare@merrithew.com

416.482.4050 | 1.800.910.0001 | 0800.328.5676 UK | ext. 0907

Take Advantage of our Training Tools

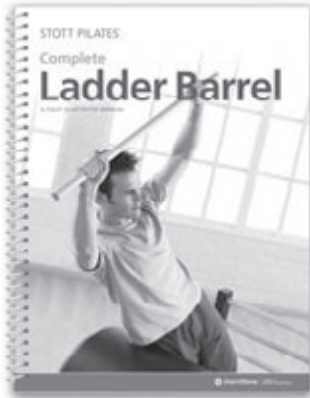

Training Manuals: Developed for our Instructor Training Program, and fully illustrated, offers step-by-step instruction to the complete Ladder Barrel repertoire.

Poster: Full-size wall chart, measuring 27"x39", depicts exercises featured in the STOTT PILATES® Ladder Barrel repertoire. Each exercise is described with name, one photo, and suggested repetitions.

A step-by-step exercise guide for the Ladder Barrel repertoire can be downloaded by visiting merrithew.com/guides



Instructional DVDs: We offer almost limitless exercise challenges in our clear and detailed repertoire of cutting edge titles. For a full listing visit merrithew.com/shop/dvds

Make the Most of Merrithew™ Equipment

As Leaders in Mindful Movement™, Merrithew is committed to developing unique, top-quality fitness programs based on the latest in exercise science and research. Our signature STOTT PILATES® education is unparalleled, and we bring the same expertise and passion to our full range of branded programs, including CORE™ Athletic Conditioning and Performance Training™, ZEN-GA®, Total Barre™ and Halo® Training. Join our global community of elite fitness professionals. Merrithew courses and workshops are offered worldwide.

Find courses and workshops near you at merrithew.com/education/training

Contact Us 416.482.4050 | 1.800.910.0001 | 0800.328.5676 UK | ext. 300



IMPORTANT

Please keep this manual in a safe place.



2200 Yonge Street, Suite 500, Toronto, Ontario, Canada M4S 2C6
416.482.4050 | 1.800.910.0001 | 0800.328.5676 UK | ext. 0907
customer@merithew.com | merrithew.com