

# Stability Chair™



Please review this important **assembly, safety** and **warranty** information about your new Merrithew™ equipment and keep it handy for future reference.

## IMPORTANT!

This manual contains important assembly, safety and warranty information. Read the manual carefully before using your new equipment and keep the manual on hand for future reference.

**UNSAFE OR IMPROPER USE OF THIS EQUIPMENT BY FAILING TO READ AND COMPLY WITH ALL REQUIREMENTS AND WARNINGS COULD RESULT IN SERIOUS INJURY.**

It is impossible to predict every situation and condition that can occur while using this equipment. Merrithew makes no representation about the safe use of any exercise equipment that cannot be predicted or avoided.

**PLEASE READ THESE INSTRUCTIONS COMPLETELY BEFORE BEGINNING ASSEMBLY.**

Merrithew recommends cautious assembly and usage and wishes you many hours of safe and effective exercise.

## User Guidelines

Pilates equipment when used effectively can facilitate many Pilates exercises safely and effectively. However, care and caution must be taken as there are some inherent dangers when using any exercise equipment — especially when spring resistance is involved.

**For inexperienced or first-time users, this equipment should only be used under the supervision of a trained professional.**

Please ensure that you and your clients/patients have received proper instruction regarding the correct and safe use of this equipment.

This manual includes general guidelines for setup and usage. To get the most out of this equipment, Merrithew offers instructional DVDs and manuals. Personalized training is offered through our Corporate, Licensed and Host Training Centers. Visit [merrithew.com](http://merrithew.com) for more information.

## Mechanical Safety Check

**Proper maintenance and timely replacement of your equipment or component parts is your responsibility.**

**Conduct a regular inspection of the following:**

**Daily:** Clean upholstery after each use, using warm water with mild soap and clear water rinses for day-to-day cleaning. Wipe down metal surfaces as needed with a damp cloth (water only).

**Weekly:** Inspect all springs for wear and damage and replace immediately as needed.

**FAILURE TO PERFORM RECOMMENDED SAFETY CHECKS, OR USING EQUIPMENT WITH IMPROPERLY ADJUSTED, BROKEN OR WORN PARTS, COULD RESULT IN SERIOUS BODILY INJURY.**

**Monthly:**

- ▶ Ensure eyehooks are securely fastened.
- ▶ Ensure all nuts, bolts and screws are securely fastened.
- ▶ Check wear on star knobs and replaced as needed.

**Every Two Years:** Replace all springs



### CAUTION

**IMPROPER USE OF EXERCISE EQUIPMENT MAY CAUSE SERIOUS BODILY INJURY. TO REDUCE RISK, PLEASE READ THE FOLLOWING:**

- ▶ The Stability Chair should be used under the supervision of a trained professional.
- ▶ Before starting any exercise program, consult a physician.
- ▶ Before using the equipment, read and follow the safety instructions in this Manual and obtain instruction from a qualified trainer.
- ▶ Use equipment only for intended exercises.
- ▶ Ensure the equipment is properly adjusted for your size and ability level.
- ▶ Stop exercising if you experience chest pain, feel faint, have difficulty breathing, or experience musculoskeletal discomfort.
- ▶ Keep body, clothing and hair free from all moving parts.
- ▶ Do not use if equipment appears worn, broken or damaged.
- ▶ Do not attempt to repair equipment yourself without consulting Merrithew.
- ▶ Do not allow children to use or be around equipment without adult supervision.
- ▶ All springs must be replaced every 24 months or as needed within that period.
- ▶ The Stability Chair should only be used by only one person at a time, not weighing over 350 lbs / 159 kgs.

**WARNING: As with any athletic activity, the use of exercise equipment involves risk of injury, damage and/or death.**

**By choosing to use Merrithew equipment, you and/or your clients/patients assume responsibility for that risk, not the organizations who sell, distribute and/ or manufacture this equipment.**

# Stability Chair™

- 1 Chair Seat
- 2 3-Prong Knob (1/4" x 1")
- 3 Pop-Up Pin (5/16")
- 4 Handle Receptacle (R/L) \*
- 5 Wooden Sides (R/L)
- 6 Chair Handle (R/L)\*
- 7 Seat Support
- 8 Pedals
- 9 Horizontal Frame complete with Pedal
- 10 Pedal Lock [fig. A]
- 11 4-Prong Star Knob [fig. A]
- 12 Heavy Chair Springs (red) [fig. B]
- 13 Light Chair Springs (blue) [fig. B]
- 14 Vertical Frame [fig. B]
- 15 Serial Number Sticker [fig. C]
- 16 Chair Handle Chrome Extension (R/L) [fig. D]\*
- 17 Easy-Roll Wheels

\*Included with Split-Pedal Stability Chair with Handle models only.

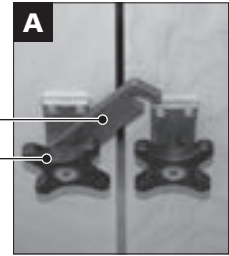

PEDALS LOCK TOGETHER FOR USE AS A SINGLE PEDAL

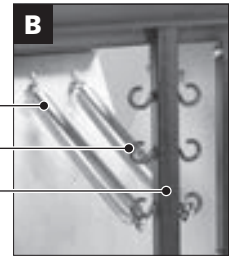

VIEW FROM BACK: VERTICAL FRAME AND SPRINGS



SERIAL NUMBER IS APPLIED ON THE UNDERSIDE OF THE CHAIR SEAT

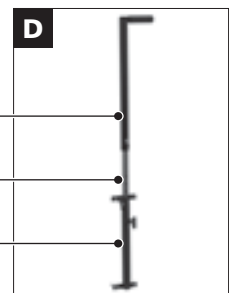

CHAIR HANDLE

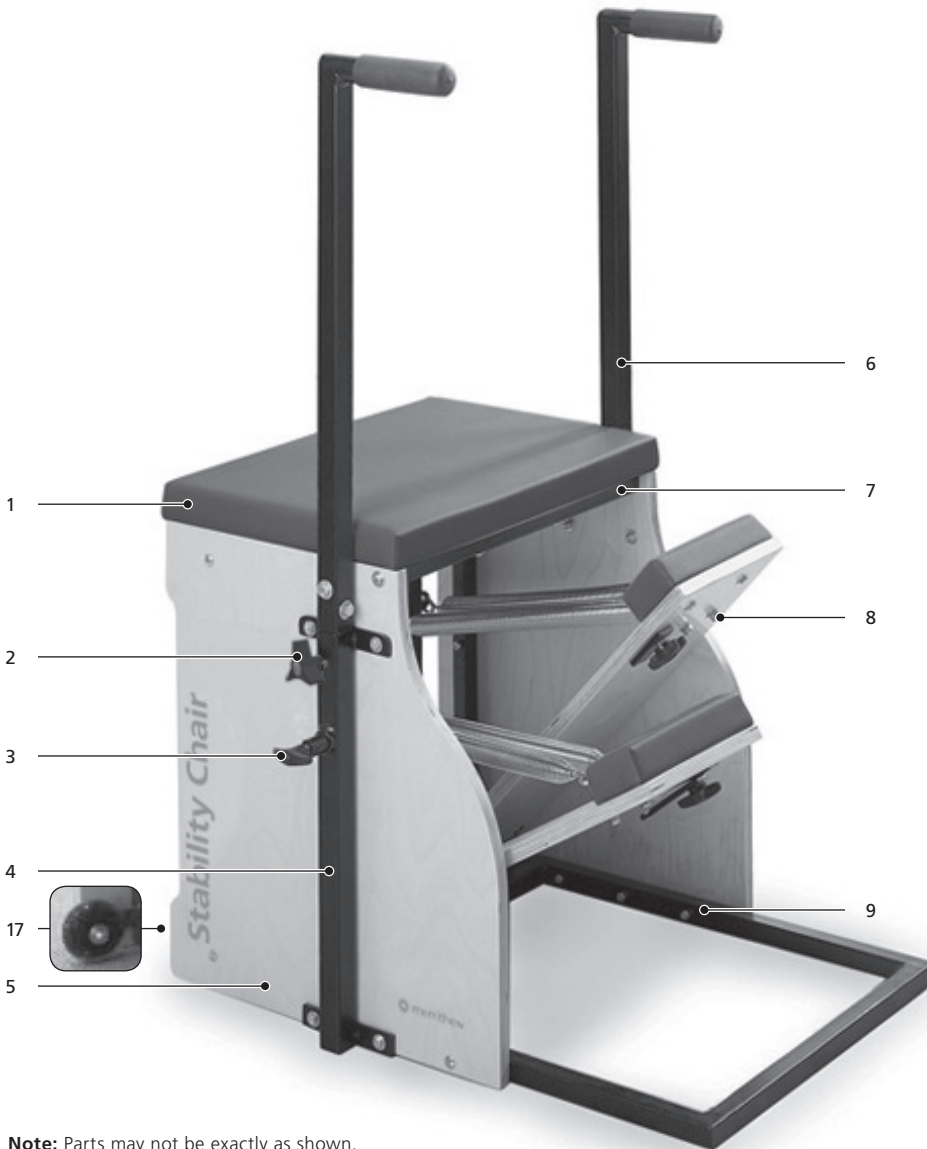









ALSO AVAILABLE WITHOUT HANDLES



**Note:** Parts may not be exactly as shown.

# Assembling the Stability Chair

**IMPORTANT: Do not tighten any bolts or screws during assembly until you are instructed to do so.**

- ▶ Place all parts from the box in a cleared area and position them on the floor in front of you.
- ▶ Remove all packing materials from the area and place them back into the box. Do not dispose of the packing materials until assembly is completed.
- ▶ To prevent unsafe or improper use, please read each step carefully before beginning or refer to our online assembly video at [merrithew.com/eq-assembly](http://merrithew.com/eq-assembly)

Hardware Required			
PART NUMBER	ITEM		QTY SUPPLIED
17	 Bolt, Carriage (1/4"x 2")		8
18	 Bolt, Hex (1/4"x 1-1/2")		6
19	 Bolt, Hex (1/4"x 2-1/4")		4
20	 Bolt, Hex (3/8"x 3/4")		4
21	 Bolt, Hex (1/4"x 2")		8
22	 Nylock Nut (1/4")		16
23	 Washer (1/4")		18
24	 Washer (3/8")		4

Required Tools	
	Universal Assembly Tool ( <i>supplied</i> )
	7/16" (12 mm) Wrench <b>or</b> Adjustable Wrench
	Rubber Mallet <b>or</b> Hammer



**1. ALL MODELS** Unfold pedals from horizontal frame [9] and attach the wooden sides [5] to each side of the frame with one 1/4"x 2" carriage bolt [17] and nut [22] ensuring ensuring that the Logos are facing outward. Do not tighten.



**2. ALL MODELS** Slide vertical frame [14] between the two wooden sides [5] at the back, making sure the wheels are facing to the outside. Match the three holes on each side of the wooden sides [5] with those on the vertical frame [14] and attach them loosely with six 1/4"x 2" carriage bolts [17] and nuts [22]. **Do not tighten.**

**NOTE:** Gently tap all carriage bolts from the outside to set them into the wood. Then tighten the nuts on the inside.



**3. ALL MODELS** Attach the seat support [7] between the two wooden sides [5] at the front, using two 1/4"x 1-1/2" hex bolts [18] with washers [23] on the outside, making sure the holes for the chair seat are facing upwards.



**4a. MODELS WITHOUT HANDLES** Attach the wooden sides [5] to the horizontal frame [9] using 1/4"x 2" carriage bolts [17] and nuts [22]. Insert two 1/4"x 1-1/2" hex bolts [18] and nuts [22] with washers [23] in remaining holes on the wooden sides [5]. Tighten all hardware. *If your chair has handles, see next page.*



**4b. MODELS WITH HANDLES** Lift the pedal to access the horizontal frame and fasten the bottom end of the chair handle receptacles [4] to the wooden sides [5] and the horizontal frame [9] using two 1/4"x 2-1/2" hex bolt [19] and nuts [22] with washers [23] on the outside only. **Check that the three prong knob [2] at the top is facing away from the pedals.** Attach the top end of chair handle receptacles [4] to the wooden sides, using two 1/4"x 1-1/2" hex bolts [18] and nuts [22] with washers [23] on both sides.

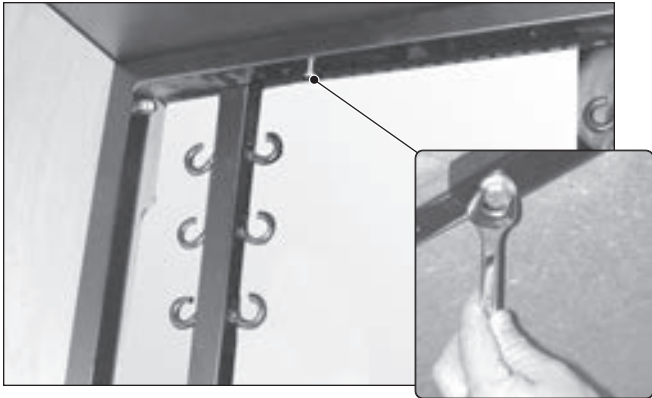

**5. ALL MODELS** Place the chair seat [1] on top, aligning the edges of the seat with the wooden sides [5]. From the underside, attach the seat to the frame using four 1/4"x 2" hex bolts [21] with washers [23]. Tighten all hardware.

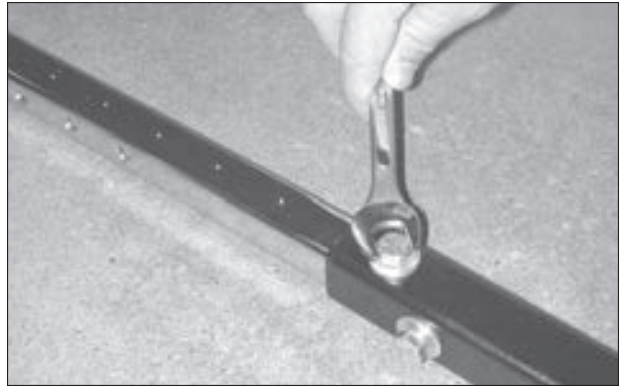

**6. MODEL WITH HANDLES** Assemble the chair handles [6] and chair handle chrome extensions [16] together using two 3/8"x 3/4" hex bolts [20] with washers [24] and tighten.

**NOTE:** Chair Handles [6] and Chair Handle Chrome Extensions [16] come as right and left. To determine correct placement, ensure the three prong knob [2] is facing AWAY from the pedals.

# Assembling the Stability Chair cont'd



**7. MODELS WITH HANDLES** Loosen the 3-prong knob [2] on the chair handle receptacle [4], unscrew and pull out the pop-up pin [3] and insert the chair handle [6, 16] fully into the receptacle.

**Ensure that the bolt head faces out to prevent damage to the vinyl of the chair seat [1] and that the handle [6] faces towards the pedal.** Release the pop-up pin [3] ensuring it sits completely in one of the holes and tighten the 3-prong knob [2] to secure the handle in the receptacle [4]. There is no need to tighten the pop-up pin.

To adjust the handles, loosen the 3-prong knob [2], pull out the pop-up pin [3], and position the handle at the desired height. Release the pop-up pin, ensuring that it sits completely in one of the holes and tighten the 3-prong knob. Make sure that both handles are set at the same height. When performing exercises with the handles, ensure pop-up pins are securely inserted into handles and both star knobs have been fully tightened.

**NOTE:** Do not tighten pop-up pins.



**8. ALL MODELS** Attach the springs to hooks on the pedal [8] first, then to the hooks on the vertical frame [14]. The heavy chair (red) springs [12] attach to the inner eyehooks and the light chair (blue) springs [13] attach to the outer eyehooks.

**NOTE:** To change the spring tension, only unhook the springs from the vertical frame. The springs should remain attached to the pedals at all times. Do not have any weight on the pedal(s) when changing springs. When changing springs, always leave one spring on while moving the desired spring into place to ensure the pedal does not fall.



**9. SPLIT PEDALS** The Split-Pedal Chair has two pedals that can move independently or, locked together, form one pedal.

**To join pedals:** Loosen both star knobs [11] and rotate pedal lock [10] to hook onto metal shaft of star knob. Tighten both star knobs.

**To split pedals:** Loosen both 4-prong star knobs [11] and lift open side of pedal lock [10] from star knob and rotate so it is completely under one pedal. Tighten both star knobs. When splitting pedals, make sure a spring is attached on both sides, as pedal will fall if unsupported.

## Care and Cleaning

Wipe vinyl surfaces using warm water with mild soap and clear water rinses for day-to-day cleaning. Ensure soap does not leave an oily residue, or make surfaces slippery.

Clean all metal surface areas as required, using a soft cloth and gentle cleaner.

If necessary, hinges can be cleaned with a cloth and window cleaner, (spray cleaner onto the cloth first, not directly on the equipment). It is not necessary to lubricate the hinges.

**CAUTION:** We do not recommend using chemical-based products.

# Set-Up and Precautions

Full instructions on proper set-up and execution of each exercise is provided in the STOTT PILATES™ Complete Stability Chair manual. This safety manual includes general guidelines only.

Improper use of exercise equipment may cause serious injury. To reduce risk, please observe the following:

## For Your Safety

- ▶ **Do not lift Stability Chair from chair seat, grip metal frame instead.**
- ▶ Be careful that skin does not get caught when attaching and detaching springs.
- ▶ Ensure springs are securely hooked on the eyehooks.  
**If a spring is not secure, it may unhook and detach with high force.**
- ▶ When changing springs, always leave one spring on while moving the desired spring into place to ensure the pedal does not fall.
- ▶ Care must be taken when seated or standing on the Stability Chair, ensuring there is sufficient surface area available to maintain balance during the exercise.
- ▶ In exercises where weight is displaced away from the Stability Chair (e.g. Spring Eagle), a trained professional must sit on the Chair to provide counterbalance.  
**Never stretch off the side of the Chair or swing from the handles as this may cause it to tip.**
- ▶ Be careful to not place fingers or toes underneath the pedal or on top of the metal base of the Stability Chair.
- ▶ Take care when attempting any new exercises, as the pedal may propel the exerciser forward or leave them in a precarious position without sufficient support.
- ▶ When hands or feet are on the pedal, ensure they are secure and will not slip.  
**If the pedal is released suddenly, the force of the springs may cause injury, or the exerciser may lose balance and fall.**
- ▶ Gripper Mats may be used to prevent slipping.
- ▶ Proper fitness apparel (including sticky socks) is recommended while using this equipment.
- ▶ Be careful to keep fingers, toes, clothing and hair away from the space between the two pedals.
- ▶ When moving the Stability Chair, grasp the handles and tilt the side with the wheels towards you.

## Springs

Four springs in two tensions and three spring tension locations make the Stability Chair highly versatile and easily adjustable to accommodate each user's abilities and strengths.

- ▶ When attaching springs, hook them to the pedal first, then to the vertical frame. During regular use, change springs by unhooking them from the vertical frame only.
- ▶ Springs should remain attached to the pedal at all times.
- ▶ Always attach the heavy springs to the inner eyehooks and light springs to the outer eyehooks.
- ▶ When changing springs, always leave one spring on while moving the desired spring into place to ensure the pedal does not fall.
- ▶ Do not have any weight on the pedal(s) when changing springs.

## Split-Pedals

The Split-Pedal Chair has two pedals that can move independently or, locked together, form one pedal. Splitting the pedals allows you to work bilaterally, unilaterally and reciprocally to rebalance muscle and challenge core stability.

### To join pedals:

Loosen both star knobs and rotate lock, ensuring it completely hooks onto metal shaft of star knob. Tighten both star knobs.

- ▶ Check to ensure that the lock is fully secured in place by the star knobs prior to using

### To split pedals:

Loosen both star knobs and lift open side of lock from shaft or star knob and rotate so it is completely under one pedal. When splitting pedals, make sure a spring is attached on both sides, as pedal will fall if unsupported.

## Handles – for models with handles

Handles provide support in some standing and sitting exercises. They are easily inserted and lock securely into place. Handles can be purchased separately and installed later by the user.

### To insert or adjust handles:

Loosen 3-prong star knob. Pull pop-up pin and insert chair handle into chair handle receptacle. Ensure bolt head faces away from the seat vinyl. Release pop-up pin at desired height and tighten 3-prong star knob to secure handle in receptacle.

- ▶ When performing exercises with the handles, ensure pop-up pins are securely inserted into handles and both star knobs have been fully tightened.

**Do not tighten pop-up pins.**

# Replacement Parts

For more information and to place an order, visit [merrithew.com/replacementparts](http://merrithew.com/replacementparts) or email [equipment@merrithew.com](mailto:equipment@merrithew.com)

## Pop-Up Pin



Use to adjust the height of the chair handles [6]

## 3-Prong Knob



Use to lock or unlock the chair handles [6]

## 4-Prong Star Knob



Use to lock or unlock pedals [8]

## Spring Package



Replace springs every 24 months, or as needed within that period. A complete replacement spring package is available and includes:

- ▶ 2 light chair springs (blue)
- ▶ 2 heavy chair springs (red)

## ACCESSORIES

# Optional Items

## Stability Chair Handles



Updater kit for models without handles. Includes hardware and handles.

## Eco-Friendly Pilates Pads



Non-slip eco-friendly pads can help establish correct alignment and positioning or to provide cushioned support.

## Gripper Mats

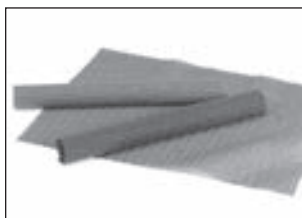

Non-slip rubber mats are handy to increase traction and prevent slipping.

## Foam Cushions



Available in three sizes. Used for comfort and additional support when performing a wide variety of exercises.

- A:** 9"x 6"x 1" / 23 x 15 x 2.5 cm
- B:** 9"x 6"x 3" / 23 x 15 x 7.6 cm
- C:** 13"x 10"x 2.5" / 33 x 25.4 x 6.4 cm





# Warranty

Merrithew™ warrants that all new equipment is free of manufacturing defects in workmanship and materials, subject to the terms below. This warranty becomes effective at the invoice date of the original purchase. Parts repaired or replaced under the terms of this warranty will be warranted for the remainder of the original warranty period.

It is the purchaser's responsibility to notify the Company of any change of contact information. This ensures, that in the unlikely event of a replacement or safety notice, we are to contact you immediately.

#### **This warranty applies to equipment only:**

- ▶ While it remains in the possession of the original purchaser and proof of purchase is demonstrated
- ▶ If claims are made within the part-specific warranty period
- ▶ If upgrades are made as required by Merrithew

#### **This warranty shall be null and void if:**

- ▶ **Equipment failure is a result of improper assembly, installation or maintenance**
- ▶ **The equipment is used for any other purpose other than as intended, or is stored or used outdoors, or in environments without adequate climate/humidity controls**
- ▶ **Equipment has been subjected to accident, misuse, abuse, improper service, or any modification not authorized by Merrithew**

This warranty does not cover damage to the finish of any equipment nor shipping charges, customs clearance fees (if applicable), or any costs incurred in installing repaired or replacement parts shipped under the provisions of this warranty.

Failure to change springs every two (2) years may void warranty.

#### **Limited Lifetime Warranty**

Merrithew will, at its option, repair or replace any of the parts listed below, provided that the part(s) fail due to a defect in workmanship or materials and provided such failure occurs and is reported with part-specific warranty period.

#### **Two (2) Year Limited Warranty**

Merrithew will, at its option, repair or replace all other components other than upholstery that fail for any reason, provided such failure is reported to Merrithew within a period of two years from the invoice date of the original purchase.

#### **90-Day Upholstery Fabric Warranty**

The vinyl fabric upholstery and spring sleeves will be replaced if they fail to give normal wear for 90 days after delivery. Proof of damage may be required. This warranty does not cover cuts, burns, stains, soiling, pet damage or damage caused by other unreasonable use. This warranty does not apply to fabrics cleaned with abrasive, corrosive or chemical cleansers. If the identical fabric is not available, Merrithew will provide an equivalent.

#### **Disclaimer of Implied Warranties and Limitation of Remedies**

Repair or replacement of defective parts is your exclusive remedy under the terms of this limited warranty. In the event of parts availability issues, Merrithew will not be responsible for any consequential or incidental damages arising from the breach of either this limited warranty or any applicable implied warranty, or for failure or damage resulting from acts of nature, improper care and maintenance, accident, alteration, replacement of parts by anyone other than Merrithew, misuse, transportation, abuse, hostile environments (inclement weather, acts of nature), improper installation or installation not in accordance with local codes or printed instructions.

**This limited warranty is the sole express warranty given by Merrithew. No product performance, specification or description wherever appearing is warranted by Merrithew except to the extent set forth in this limited warranty. Any implied warranty protection arising under the laws of any state, province or territory including implied warranty of merchantability or fitness for a particular purpose, or use, is hereby limited in duration to the duration of this limited warranty.**

Neither distributors, dealers, web resellers, nor the retailers selling this product have any authority to make any additional warranties or to promise remedies in addition to, or inconsistent with those stated above. Merrithew's maximum liability, in any event, shall not exceed the purchase price of the product paid by the original purchaser.

## IMPORTANT

**Please keep this manual in a safe place.**

**If you have questions, issues or are missing parts:**

**Do NOT return this unit to your local retailer, please contact the manufacturer directly.**

**customercare@merrithew.com**

**416.482.4050 | 1.800.910.0001 | 0800.328.5676 UK | ext. 0907**

# Take Advantage of our Training Tools



**Training Manuals:** This fully illustrated manual developed for our Instructor Training Program offers step-by-step instruction to the complete Stability Chair repertoire.

**Wall Chart:** Full-size poster measuring 27"x39", depicts exercises featured in the STOTT PILATES® Stability Chair repertoire. Each exercise is described with name, equipment accessories, a photo, as well as suggested repetitions.



**Instructional DVDs:** We offer almost limitless exercise challenges in our clear and detailed repertoire of cutting edge titles. For a full listing visit [merrithew.com/shop/dvds](http://merrithew.com/shop/dvds)

## Make the Most of Merrithew™ Equipment

As Leaders in Mindful Movement™, Merrithew is committed to developing unique, top-quality fitness programs based on the latest in exercise science and research. Our signature STOTT PILATES® education is unparalleled, and we bring the same expertise and passion to our full range of branded programs, including CORE™ Athletic Conditioning and Performance Training™, ZEN-GA®, Total Barre® and Halo® Training. Join our global community of elite fitness professionals. Merrithew courses and workshops are offered worldwide.

Find courses and workshops near you at [merrithew.com/education/training](http://merrithew.com/education/training)

Contact Us 416.482.4050 | 1.800.910.0001 | 0800.328.5676 UK | ext. 300



# IMPORTANT

Please keep this manual in a safe place.



## Go to [merrithew.com/warranty](https://merrithew.com/warranty) to activate your warranty!

Get the benefits:

- Ensure that you'll be able to repair it under warranty should you encounter a problem.
- Make warranty service fast and efficient by having your information in our records.
- In the unlikely event of a replacement or safety notice, we'll be able to contact you immediately.
- Proof of purchase for insurance purposes in the event of a loss due to fire, flood or theft.
- Stay informed of any product updates.

### Can't get online?

Please fill out the warranty card enclosed with this product, and return to us.

This is your Stabiity Chair Serial Number:



2200 Yonge Street, Suite 500, Toronto, Ontario, Canada M4S 2C6  
416.482.4050 | 1.800.910.0001 | 0800.328.5676 UK | ext. 0907  
customer@care@merrithew.com | [merrithew.com](https://merrithew.com)